



LAYERZERO
POWER SYSTEMS, INC.

The Foundation Layer

Series 70 ePODs: Type-maX

Industrial Load Center



Product Brochure

The LayerZero ePODs: Type-maX PDU

Maximizes Operator Safety

ePODs Type-maX Is Inspired by NFPA-70E

The Series 70 ePODs: Type-maX is a Power Distribution Unit for industrial applications with high reliability requirements. It features an NFPA 70E friendly design, sectionalized layout, and the IP-20 rated Finger-Safe SafePanel, to help protect operators and ensure safe operation. With an emphasis on reliability, safety, power quality monitoring, and connectivity, the Series 70 ePODs: Type-maX provides high-reliability power distribution. The Series 70 ePODs: Type-maX is designed to be easy to work with, to minimize risk during installation, ideal for growing or constantly changing environments.



LayerZero's ePODs: Type-maX Product Features

Reliability

- ☑ **Silver Plated Input Terminals:** Silver Has Excellent Conductivity To Provide Superior Electrical Performance and Reliability
- ☑ **Machined Hardware:** Machined Cap Screws and Engineered Disc Springs Maintain Constant Torque Throughout Product Life
- ☑ **Screw Thread Inserts:** Prevents Screws From Loosening Under Vibration For Long-Term Reliability
- ☑ **Serialized Critical Board Tracking:** Critical Boards Are Serialized And Cataloged in an Active Database For Traceability
- ☑ **Transformer Vibration Isolation:** Vibro-Elastic Pads to Absorb Vibrations from the Transformer

Safety

- ☑ **InSight™ IR Portholes:** Bolted Connections Can Be IR Scanned With the Dead-Front Doors Closed
- ☑ **Sectionalized Components:** Separations Between Each Section To Maintain Maximum Operator Safety
- ☑ **Polycarbonate Windows:** Allows Circuit Breaker Positions To Be Viewed With The Dead-Front Door Closed
- ☑ **Dead Front Hinged Doors:** Barrier To Provide A Safe Working Area With No Exposed Live Parts
- ☑ **Guided Wireways:** Helps Keep Wires Organized

Connectivity

- ☑ **Ethernet Connectivity:** Secure VPN Router Connects To Network For Advanced Remote Monitoring Capabilities
- ☑ **Modbus/TCP:** Open Connectivity to Existing Monitoring Systems Without Proprietary Limitations
- ☑ **NTP Time Clock Synchronization:** Facilitates Timeline-Based Logging For Post-Event Reconstruction
- ☑ **SNMP Connectivity:** Permits Remote Management Via Simple Network Management Protocol
- ☑ **Bluetooth Connectivity:** Wirelessly Set Up Panels At The Point-Of-Impact

zenDPQM

- ☑ **Real-Time Waveform Capture:** Automatically Captures A Picture Of The Power Six-Cycles Before and After Every Event
- ☑ **Optional Local Touch-Screen Interface:** Password-Protected Color Touch-Screen GUI For Local ePODs Setup/Operation
- ☑ **Black-Box Forensics:** ePODs Captures and Records Events To Provide Vital Information In Root-Cause Analysis

All LayerZero products break down power sources into samples for power quality analysis. This data is remotely accessible by connecting to the units via web browser.

The following “voltage sag” factory test was performed on a LayerZero Series 70 ePODs: Type-X PDU. Each phase is represented by a colored line, plotting the voltage over a period of time.

In the example below, the voltage of all three phases dropped below the user-defined setpoint, which triggered an undervoltage event, an automatic waveform capture, and an ITIC plot of the event.

On LayerZero PDUs and RPPs, waveforms and ITIC plots are generated for every phase, on every circuit, for every event.

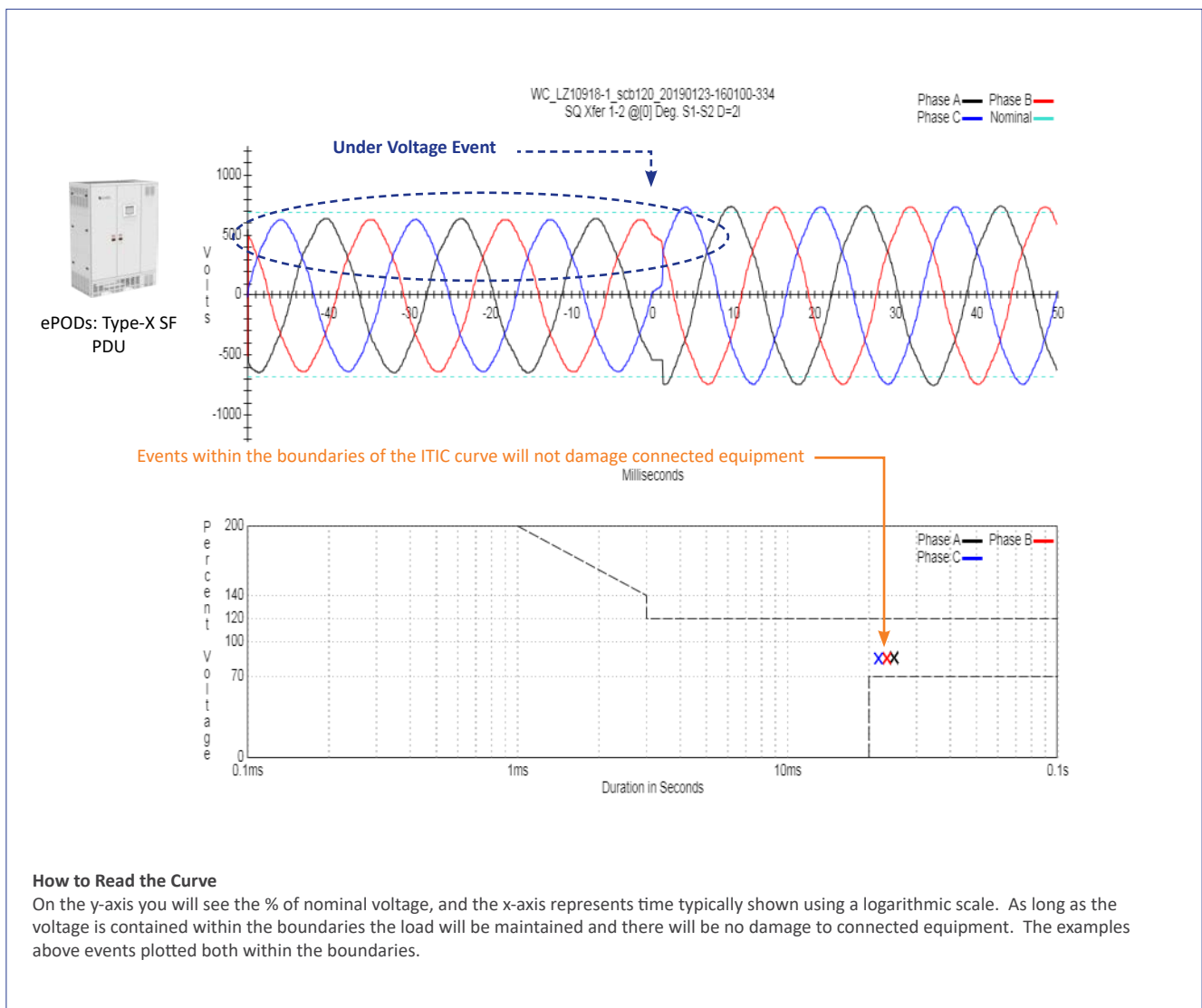

Equipment Layout

Main Circuit Breaker Section:

Auxiliary MCB optional
Mounting: Fixed, Plug-In
Type:
Molded Case Switch
65kA, 100kA
Electronic Trip
65kAIC, 100kAIC
Accessories:
CB Shunt-trip
120VAC, 24VDC
CB Position Indication:
Open, Tripped, Closed

Monitoring Section:

Color-Touch Screen Interface
Option
Local/Remote EPO Option



Distribution Section:

Sub-feed distribution
1200A SafePanel™

Transformer Section:

DOE 2016 Efficiency
Standard



Reliability Features

Silver Plated Terminals

LayerZero utilizes silver plating on all input terminals to be able to provide the highest performance. Silver has high conductivity and low resistance - which makes for a great contact.



Machined Hardware

Our bolted connections utilize machined cap screws and engineered disc springs. The result is a flat pressure vs deflection profile to ensure that all bolted connections maintain constant torque through the life of the product.

These technologies have been well tested in disparate environments of wide temperature ranges to help ensure that, once connections have been tightened, they stay that way.



Serialized Circuit Boards

We serialize and track all critical circuit boards and memory cards through our eBOSS portal, which allows customers to reference which components their machines are made from, who tested the components, as well as the ability to view notes generated from testing.

Serialized components offer the ability to drill-down on prospective component failure utilizing predictive modeling techniques, so if part fails, the instance can be cross-referenced with similar parts. This preventative maintenance helps ensure maximum uptime.

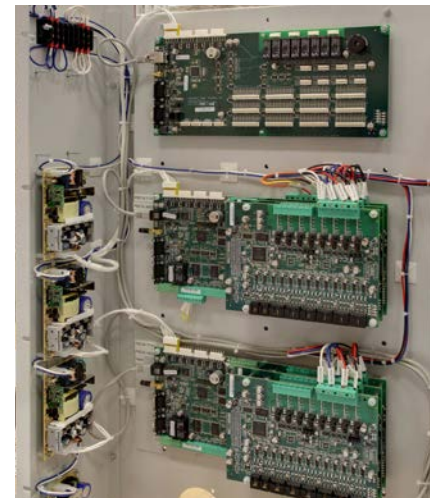

Vibration Isolation Damper Mounts

Transformers in the Series 70: ePODs Type-maX Power Distribution Unit are equipped with vibration isolation damper mounts, helping to reduce the amount of vibration and noise that originates from transformers, ultimately leading to a higher reliability of electrical and mechanical connections over the life of the product.

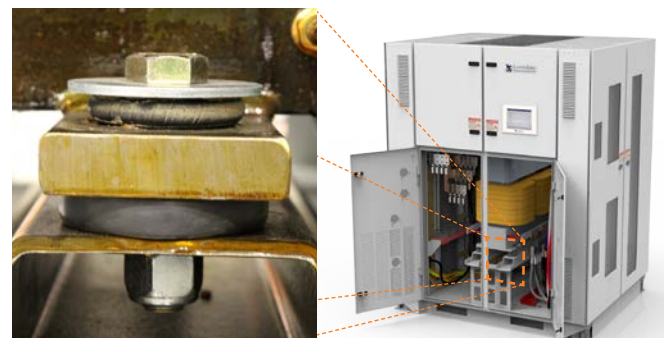

Safety

View Status LEDs and Distribution CB Positions With Dead-Front Doors Closed

Our Series 70 product line was inspired by NFPA-70E, to help data centers drastically reduce the risks of their energy distribution systems.

Operators can view the status of diagnostic LEDs without exposure to the energized power electronics section. In addition, SafePanel circuit breaker positions can be viewed with the dead-front door closed.



De-Energizable Monitoring Section

To help make maintenance easier and safer, the ePODs: Type-maX is equipped with fuses. The fuses allow the Zen DPQM Panel Board Monitor to be safely replaced or upgraded.



Safety Features

The LayerZero 1200 A Finger-Safe SafePanel™

The LayerZero 1200 A SafePanel™ Panel Board is a finger safe panel board with no exposed live parts.

The 1200 A SafePanel™ optionally includes shrouds, covering unused spaces, maximizing operator safety.



The Breaker Is Inserted Into The SafePanel



The Handle Is Unlocked



Screws Help Secure The Breaker



For Maximum Safety, The SafePanel Has Recessed Bus Work And IP-20 Finger Safe Lattice.

Connectivity Options

Bluetooth Keeps Circuit Level Information Up-To-Date

Coordinate efforts to keep panel board naming conventions accurate and up-to-date with Bluetooth connectivity. In critical facilities, Facilities typically install the physical circuit breakers, while IT workers manage naming of panel designations.

With Bluetooth connectivity, the naming, size, and assignment of circuit breakers can be taken care of at the point-of-impact, bringing together the efforts of facilities and IT for more accurate deployment.

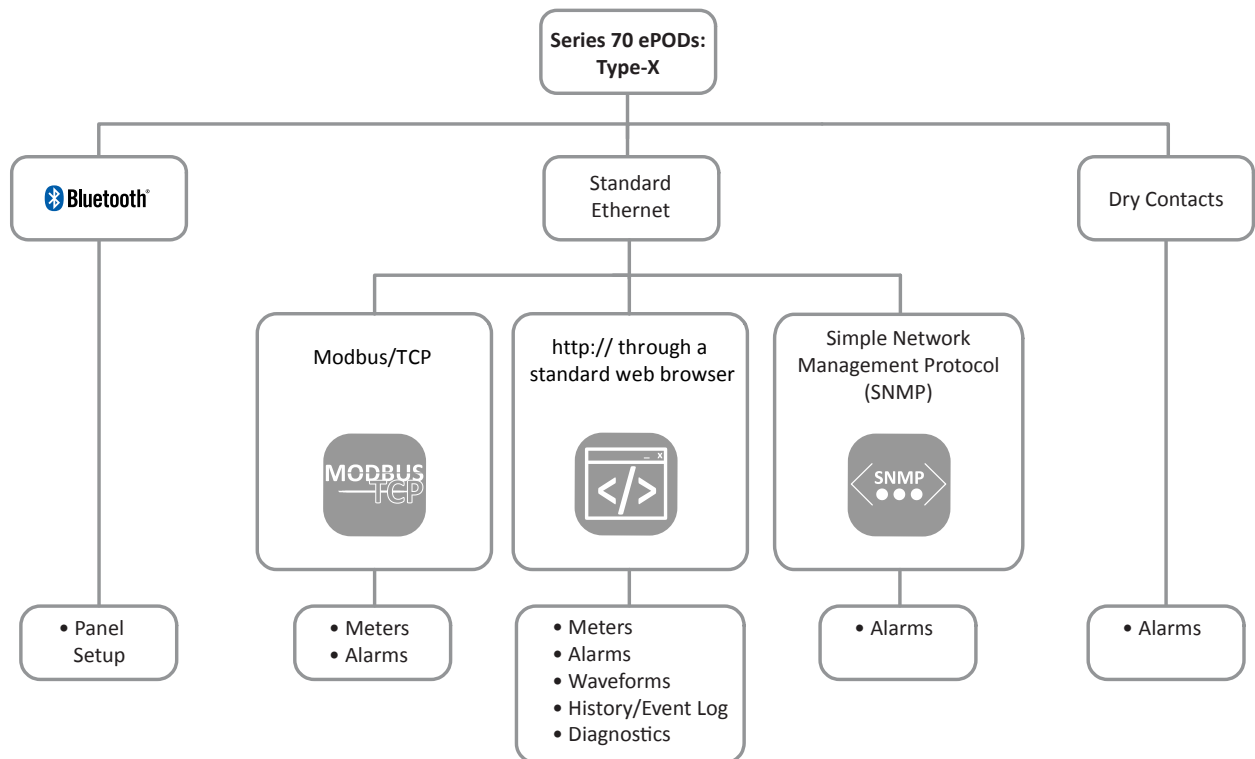

Power Quality Monitoring

zen DPQM

The Series 70 ePODs: Type-maX is equipped with Zen DPQM (Distribution Power Quality Monitoring), an all encompassing monitoring system with local and remote communications options.

From basic monitoring & alarm reporting, to advanced power quality monitoring functionality, Zen DPQM provides a wide-range of options to help you be aware, be vigilant, be proactive in your quest to create a safe, stable and reliable operation.



Zen DPQM Provides Answers

Zen DPQM provides timestamped pictures of waveforms before and after events, providing information that enables facilities to go back in time to methodically identify and correct the root causes of events. Zen actively captures power quality information at the STS, PDU, and RPP - permitting thorough post-event analysis.

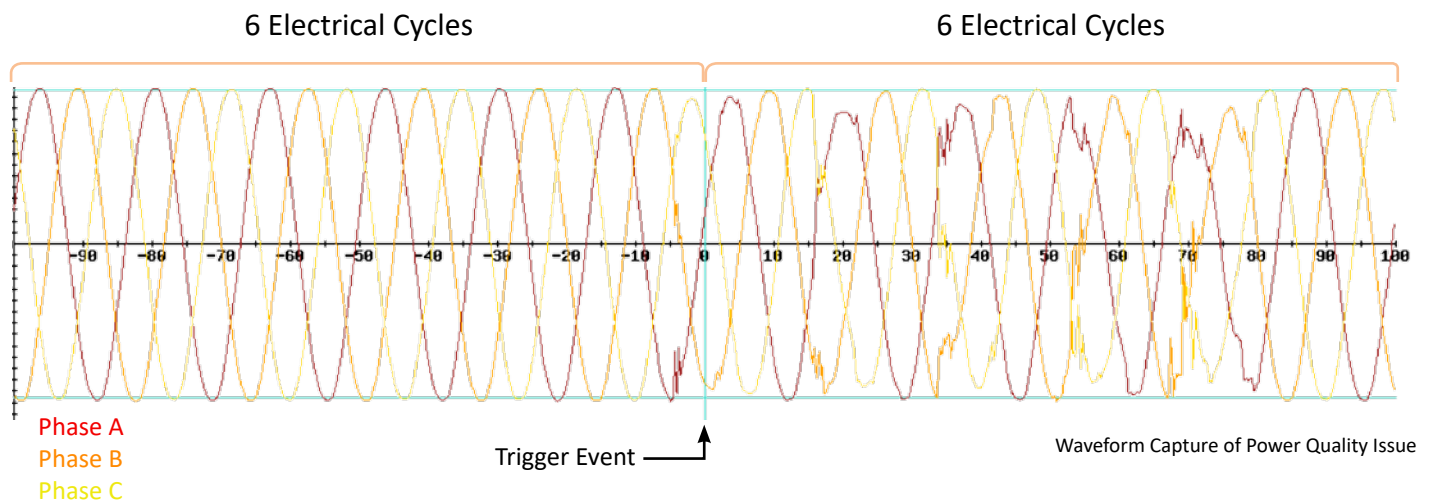

Technical Specifications



Zen DPQM Parameters		Mains	Subfeeds or Branch Circuits
Voltage Monitor	Volts (L-L) Phase A/B/C (volts RMS)	✓	
	Volts (L-N) Phase A/B/C (volts RMS)	✓	
	Phase Rotation	✓	
Current Monitor	CT Reversed Phase A/B/C/N	✓	✓
	Current Phase A/B/C/N (amperes RMS)	✓	✓
Power Monitor	Frequency (hertz)	✓	
	Real Power (kilowatts)	✓	✓
	Apparent Power (kilovolt-amperes)	✓	✓
	Reactive Power (kilovolt-amperes reactive)	✓	✓
	Power Factor	✓	✓
	Energy (kilowatt-hours)	✓	✓
	Block Demand (kilowatts)	✓	✓
	Block Demand Peak (kilowatts)	✓	✓
	Rolling Demand (kilowatts)	✓	✓
	Rolling Demand Peak (kilowatts)	✓	✓
Power Quality	Percent VTHD (percent)	✓	✓
	Waveform Capture	✓	✓
Alarms	Phase - Under Voltage A/B/C (Alarm)	✓	
	Phase - Over Voltage A/B/C (Alarm)	✓	
	Phase - Low Voltage A/B/C (Warning)	✓	
	Phase - High Voltage A/B/C (Warning)	✓	
	Phase - Over Current A/B/C (Alarm)	✓	✓
	Phase - High Current A/B/C (Warning)	✓	✓
	Under Frequency (Alarm)	✓	
	Over Frequency (Alarm)	✓	
	High VTHD (Warning)	✓	
	Over VTHD (Alarm)	✓	
	Phase Rotation (Alarm)	✓	

All product specifications are subject to change without notice.

Technical Specifications

Mechanical Characteristics	
Dimensions (Single Side Distribution)	Type-maX 92" H x 73" W x 60" D (2337 mm H x 1854 mm W x 1524mm D)
Weight	Please Contact LayerZero Engineering.
Heat Dissipation	Varies on Transformer Efficiency, Please Contact LayerZero Engineering.
Frame Construction	Welded Frame
Color	Textured Powder Coat White (RAL 7035), Blue (RAL 5017), Black, Custom
Seismic Floor Anchors	Optional
Seismic Floor Stand	Optional
Sectionalization	Dead Front Doors; Main CB(s); Monitoring; Transformer
Electrical Characteristics	
Input Voltages	Please Contact LayerZero Engineering.
Output Voltages	Please Contact LayerZero Engineering.
Transformer Size	300 kVA, 400 kVA, 500 kVA
Frequency	60 Hz
Neutral Rating	100%, 200%
Circuit Breaker Type	Electronic Trip, LS/I (Standard), LSI, LSI G Available, Thermal Magnetic Trip (100 AF Only)
Distribution	SafePanel™ Distribution
Power Quality Monitoring	
Power Quality Monitoring Technology	Zen DPQM™ (Distribution Power Quality Monitoring)
Waveform Capture	Local Display, Remote Display via Web Browser
Operational Characteristics	
Cooling	Convection Cooling
Cable Access	Top/Bottom
Service Access	Front and Side Access; Front-Only Access; or Front/Rear Access (Type-maX FR-Only)
IR Scan Port Type	InSight™ IR Portholes
Display Type	3.2" LCD with Membrane, 10.5" Color Touch Screen GUI (Optional)
Connectivity	
Meters	Local Display, Ethernet, Modbus/TCP, http via Web Browser (Non-Proprietary)
Alarms	Local Display, Ethernet, Modbus/TCP, http via Web Browser (Non-Proprietary)
Summary Alarm	Dry Contacts
Waveforms	Local Display, Ethernet, http via Web Browser (Non-Proprietary)
History/Event Log	Local Display, Ethernet, http via Web Browser (Non-Proprietary)
Diagnostics	Local Display, Ethernet, http via Web Browser (Non-Proprietary)
Time Synchronization	Network Time Protocol (NTP)
Standards Conformance: SafePanel Distribution	
UL	ETL Listed to UL 60950
CSA	C22.2 No 29-M1989

All product specifications are subject to change without notice.

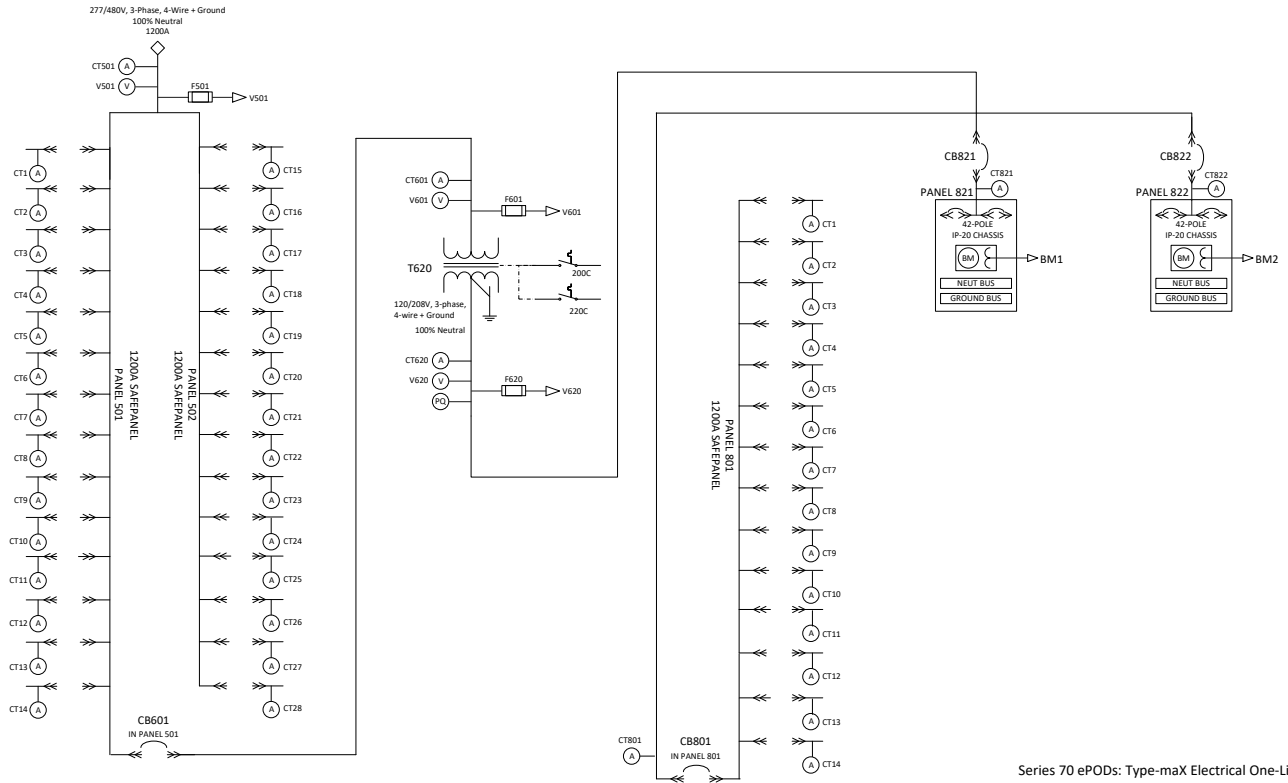

Series 70 ePODs: Type-maX Electrical One-Line Diagram

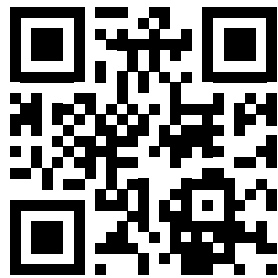

Learn more at www.LayerZero.com



LayerZero Power Systems, Inc.
1500 Danner Drive
Aurora, OH 44202 U.S.A.

© 2019 LayerZero Power Systems, Inc.

LayerZero Power Systems, LayerZero.com and the LayerZero logo are registered trademark of LayerZero.
All product specifications are subject to change without notice.

Rev. 4/19 #13